

TOP VIEW

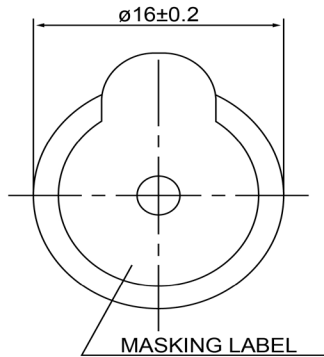

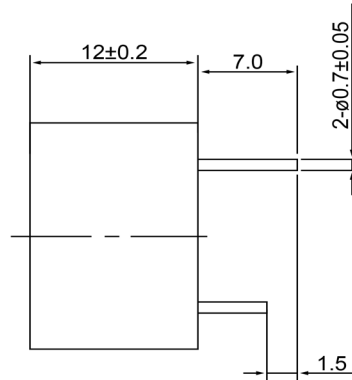

SIDE VIEW

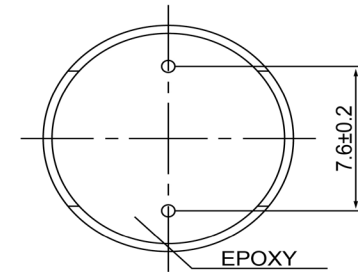

BOTTOM VIEW



Specifications			Notes	Revision History							
Description	Value	Unit		Version	Description	Date	Approved				
Technology	Electro-Mechanical		1) All dimensions are in mm unless otherwise noted 2) All parts meet RoHS	1	Released from Engineering	10/21/2013	J.S				
Resonant Frequency	2,048	(Hz)									
Rated Voltage	5	(V)									
SPL @ 10cm	85	(dBA)									
Coil Resistance	28	(ohm)									
Mount Type	Thru Hole										
Voltage Range	3 ~ 12	(V)									
Max Rated Current	55	(mA)									
Housing Material	NORYL										
Operating Temperature	-30 ~ +70	°C									
Storage Temperature	-40 ~ +85	°C									
Weight	5	(g)									
						Drawn by	Date	Checked by	Date	Approved by	Date
						A.B.	10/21/2013	C.E.	10/21/2013	J.S	10/21/2013
			Electro-Mechanical Transducer			TE162005-2					